

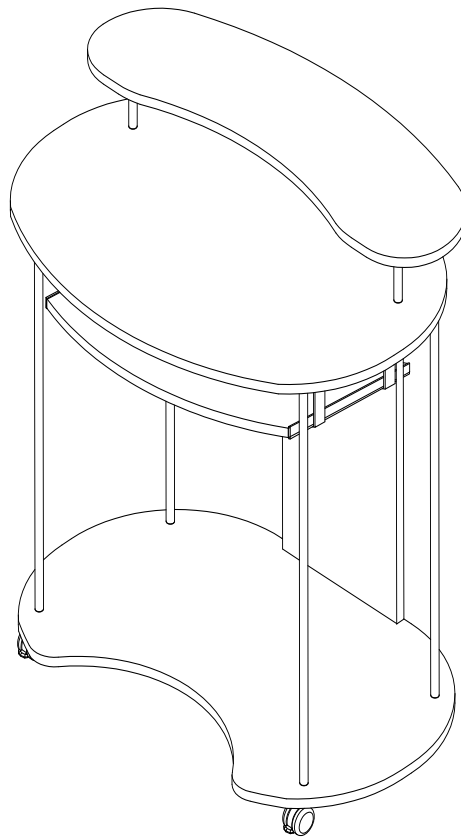









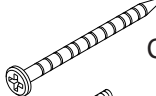
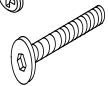

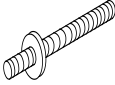





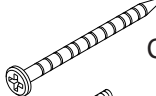
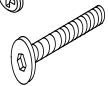

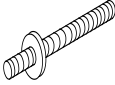





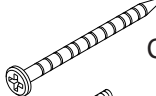
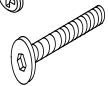

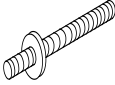

91105

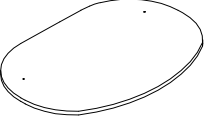
Up-Rite Standing Mobile Workstation

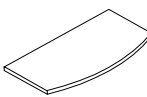

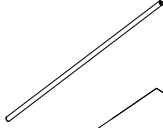
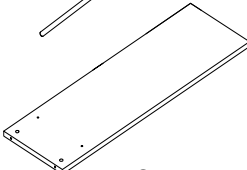
Assembly Instructions

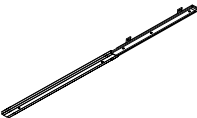
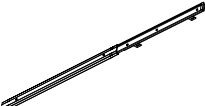
Part	Drawing	Description	Qty	Part	Drawing	Description	Qty																																								
P-1		Top Shelf	1 EA	<div style="border: 2px solid black; border-radius: 15px; padding: 10px;"> <h3 style="text-align: center;">Hardware List</h3> <table border="0"> <tr> <td>A</td> <td></td> <td>Pan Hd Screw #10x5/8</td> <td>28 EA</td> </tr> <tr> <td>A1</td> <td></td> <td>CS Wood Screw 56mm</td> <td>4 EA</td> </tr> <tr> <td>A2</td> <td></td> <td>Screw 1/4 X 50mm</td> <td>6 EA</td> </tr> <tr> <td>C</td> <td></td> <td>Cam Lock</td> <td>2 EA</td> </tr> <tr> <td>D</td> <td></td> <td>Cam Post</td> <td>2 EA</td> </tr> <tr> <td>E</td> <td></td> <td>Threaded Rod</td> <td>6 EA</td> </tr> <tr> <td>F</td> <td></td> <td>2" Locking Plate Caster</td> <td>2 EA</td> </tr> <tr> <td>G</td> <td></td> <td>2" Plate Caster</td> <td>2 EA</td> </tr> <tr> <td>H</td> <td></td> <td>Screw M4X5mm</td> <td>4 EA</td> </tr> <tr> <td>K</td> <td></td> <td>Allen Wrench</td> <td>1 EA</td> </tr> </table> </div>				A		Pan Hd Screw #10x5/8	28 EA	A1		CS Wood Screw 56mm	4 EA	A2		Screw 1/4 X 50mm	6 EA	C		Cam Lock	2 EA	D		Cam Post	2 EA	E		Threaded Rod	6 EA	F		2" Locking Plate Caster	2 EA	G		2" Plate Caster	2 EA	H		Screw M4X5mm	4 EA	K		Allen Wrench	1 EA
A		Pan Hd Screw #10x5/8	28 EA																																												
A1		CS Wood Screw 56mm	4 EA																																												
A2		Screw 1/4 X 50mm	6 EA																																												
C		Cam Lock	2 EA																																												
D		Cam Post	2 EA																																												
E		Threaded Rod	6 EA																																												
F		2" Locking Plate Caster	2 EA																																												
G		2" Plate Caster	2 EA																																												
H		Screw M4X5mm	4 EA																																												
K		Allen Wrench	1 EA																																												
P-2		Work Surface	1 EA																																												
P-3		Bottom Shelf	1 EA																																												
P-4		Keyboard Shelf	1 EA																																												
P-5		Short Tube Support	2 EA																																												
P-6		Long Tube Support	4 EA																																												
P-7		Back Panel	1 EA																																												
P-8		Slide Bracket	4 EA																																												
P-9		Left Slide	1 EA																																												
P-10		Right Slide	1 EA																																												
				<p>Tools required: Phillips Head Screwdriver</p>																																											

Assembly Diagram

To Assemble:

1. Identify and Separate all the Parts and Hardware.
2. Screw in two Threaded Rods (E) into the front threaded inserts in the bottom of the Top Shelf (P1)
Screw on two Short Tube Supports (P5) on the long section of the Threaded Rods. Screw in two Cam Posts (D) into the two rear threaded holes in the bottom of the Top Shelf as shown in illustration #1.

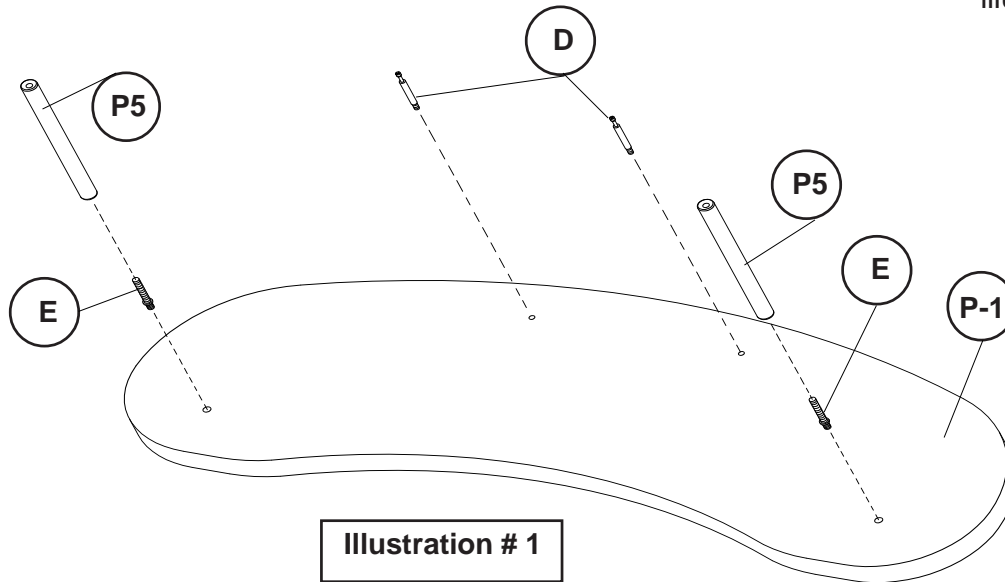

Illustration # 1

3. Place two Cam Locks (C) into the large predrilled holes in the Back Panel (P7).
Make sure the arrows on the Cam Locks are pointed down to the connecting holes in the edge. Position the Back Panel over the Cam Posts (D) and turn the Cam Locks a 1/4 turn to lock in place.

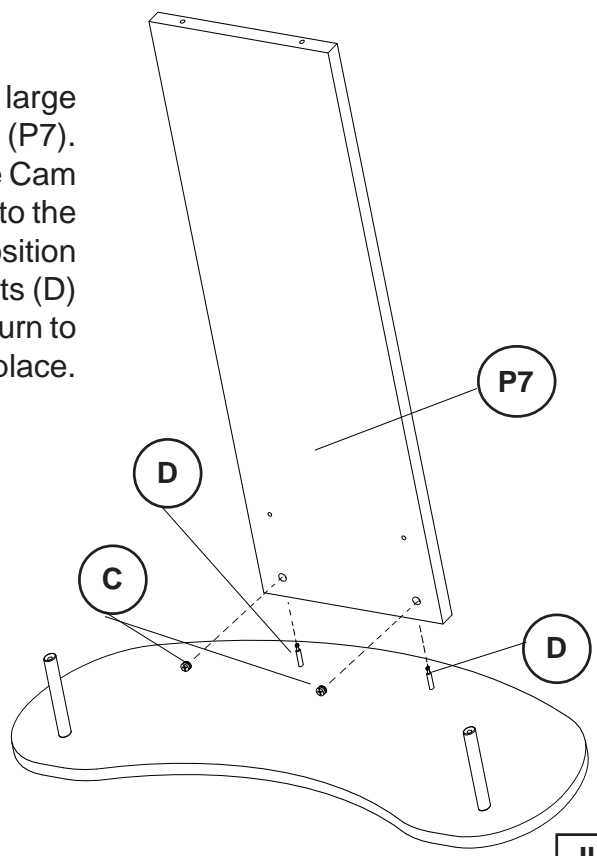

Illustration # 2

- Place the Work Surface (P2) on top of the Short Tube Supports (P5) and connect using two Screws (A2). Tighten Screws using Allen Wrench (F). Screw in two long CS Wood Screws (A1) through the predrilled holes in the Back Panel (P7) and into the holes in the edge of the Work Surface.

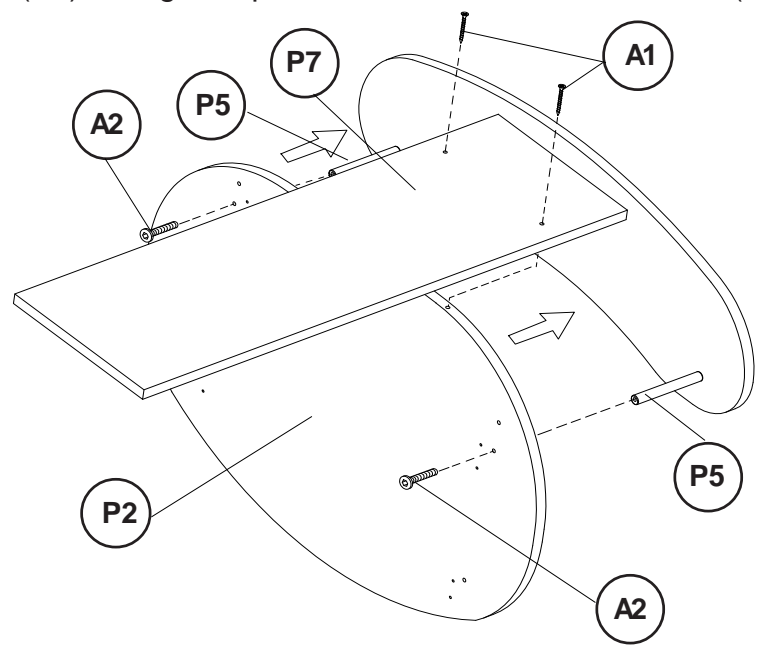

Illustration # 3

- Screw in four Threaded Rods (E) into the threaded inserts in the bottom of Work Surface (P2). Screw on four Long Tube Supports (P6) onto the long end of the Threaded Rods (E) as shown in illustration # 4.

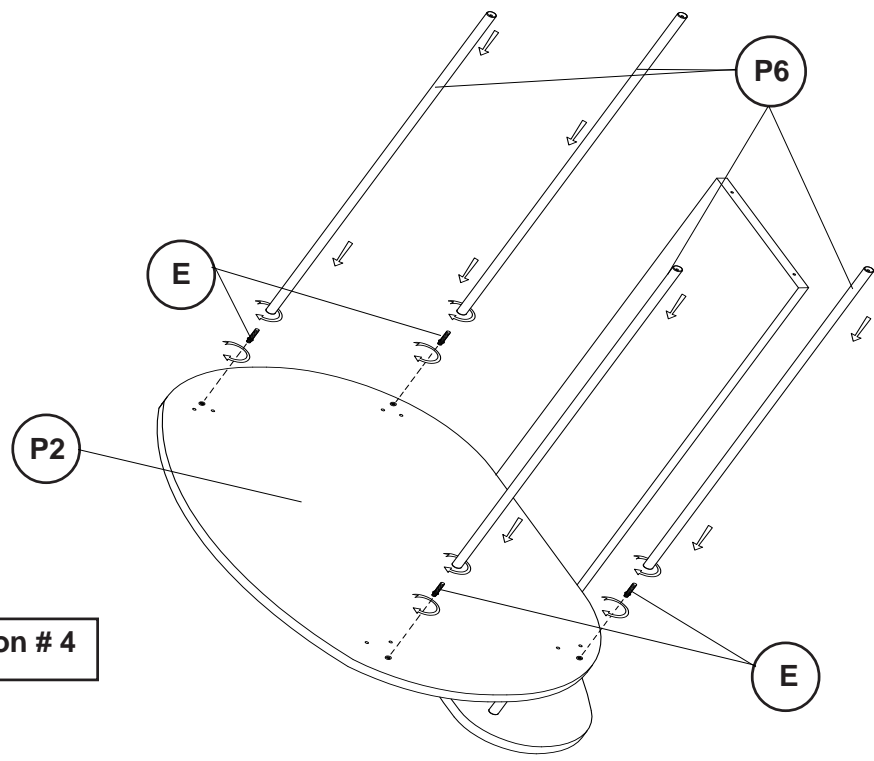
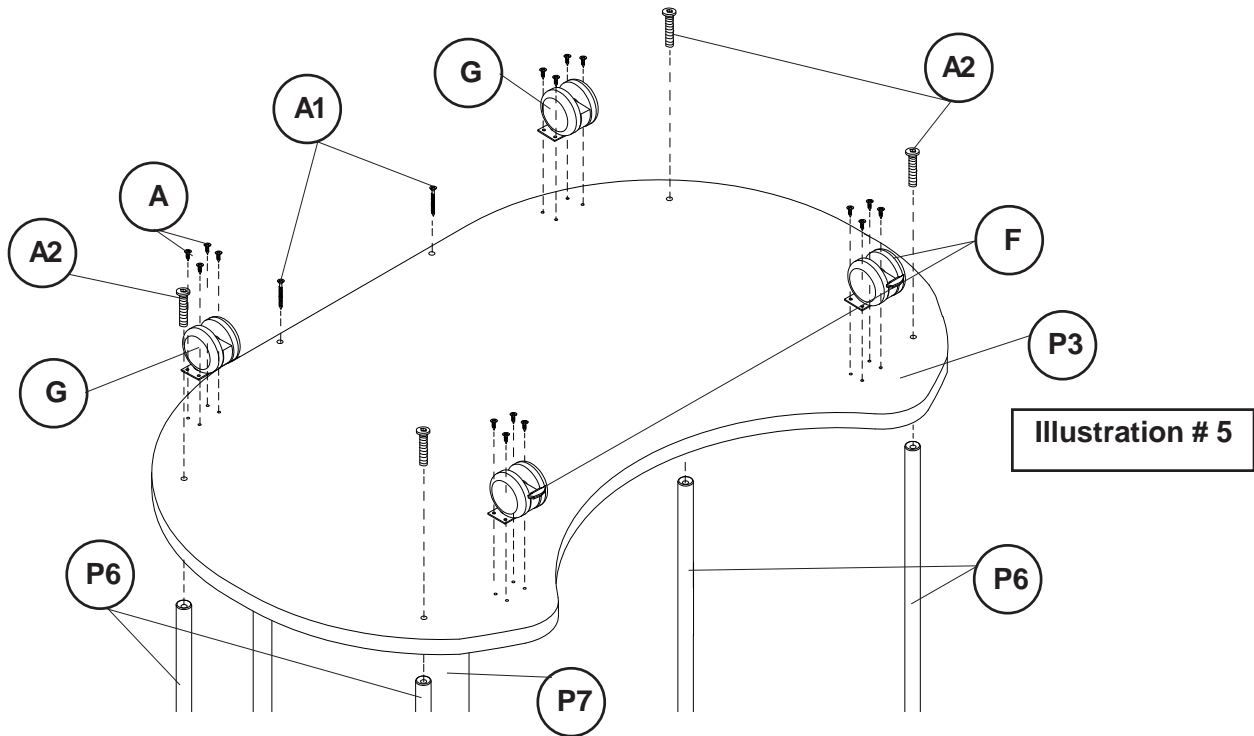

Illustration # 4

- Place the Bottom Shelf (P3) on the Long Tube Supports (P6), line up holes and secure with four Screws (A2). Attach the Bottom Shelf to the Back Panel (P7) using two CS Wood Screws (A1). Attach two Locking Plate Casters (F) to the Bottom Shelf as shown in illustration #5 using four Pan HD Screws (A). Attach two Plate Caster (G) to the bottom of the Bottom Shelf using four Pan HD Screws (A) for each as shown.



- Attach two Slide Brackets (P8) to the Left Slide (P9) using two Screws (H) as shown in illustration #6. Repeat this Step to attach two Side Brackets (P8) to the Right Slide (P10) using two Screws (H).

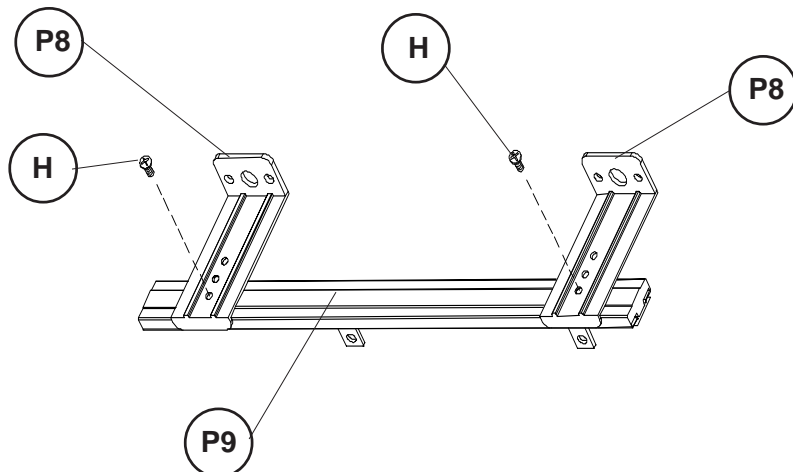
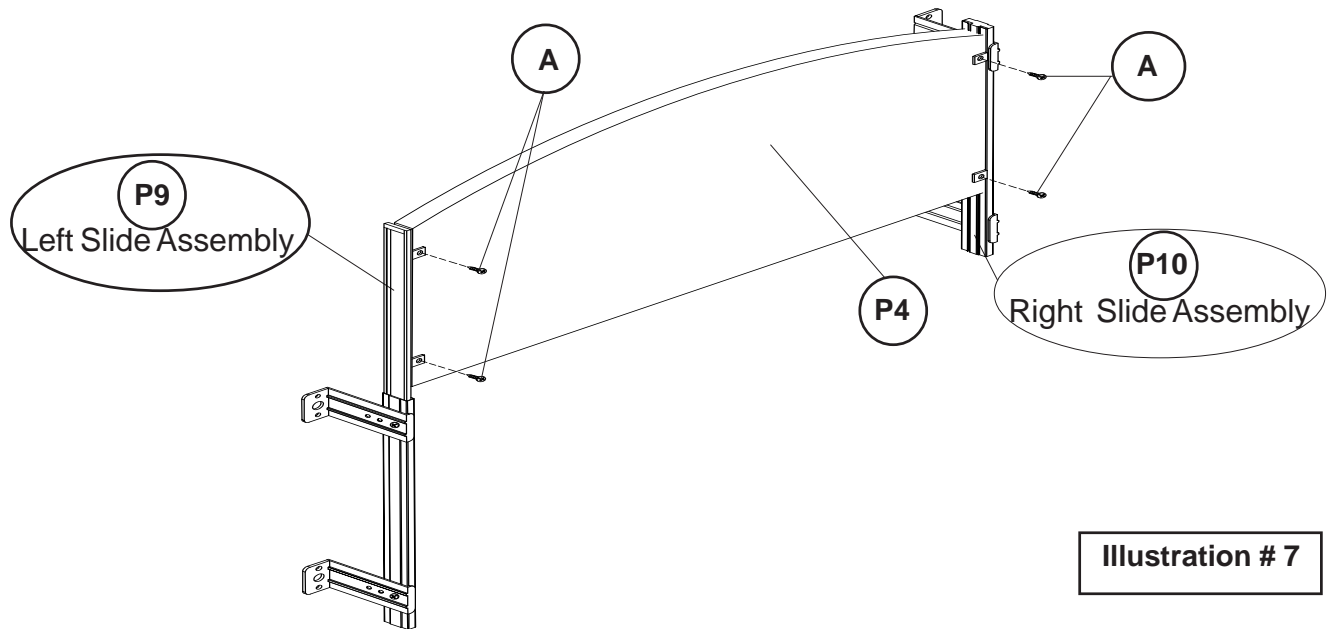
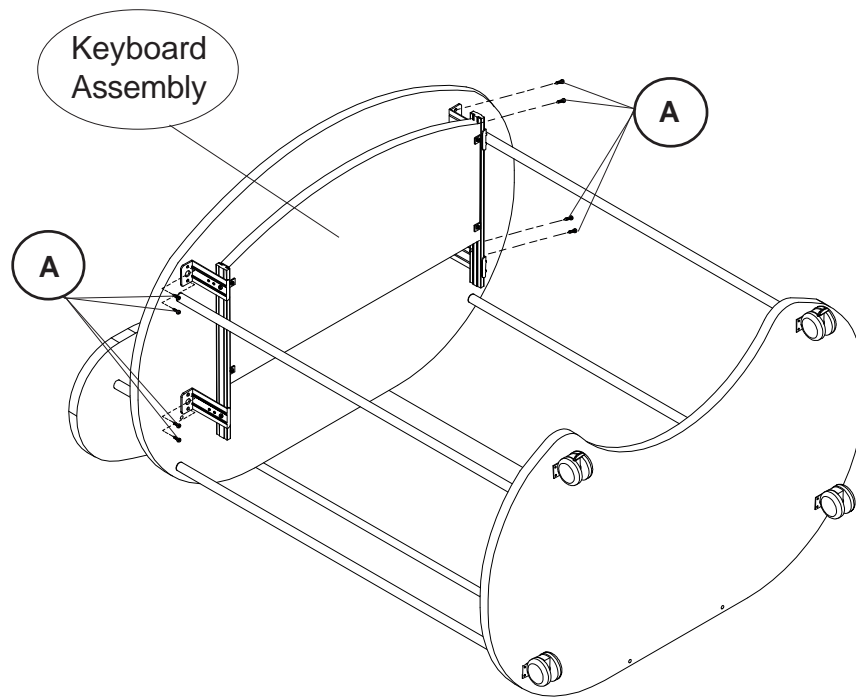

Illustration # 6

8. Attach the Left Slide assembly(P9) to the Keyboard Shelf (P4) using two Screws(A) in the bottom predrilled holes. Repeat this Step to attach the Right Slide assembly as shown in illustration #7.



9. Screw the Keyboard Shelf assembly from Step #7 to the bottom side of the Work Surface (P2) using eight Screws (A) into the predrilled mounting holes as shown in illustration #8.



91105

Up-Rite Standing Mobile Workstation

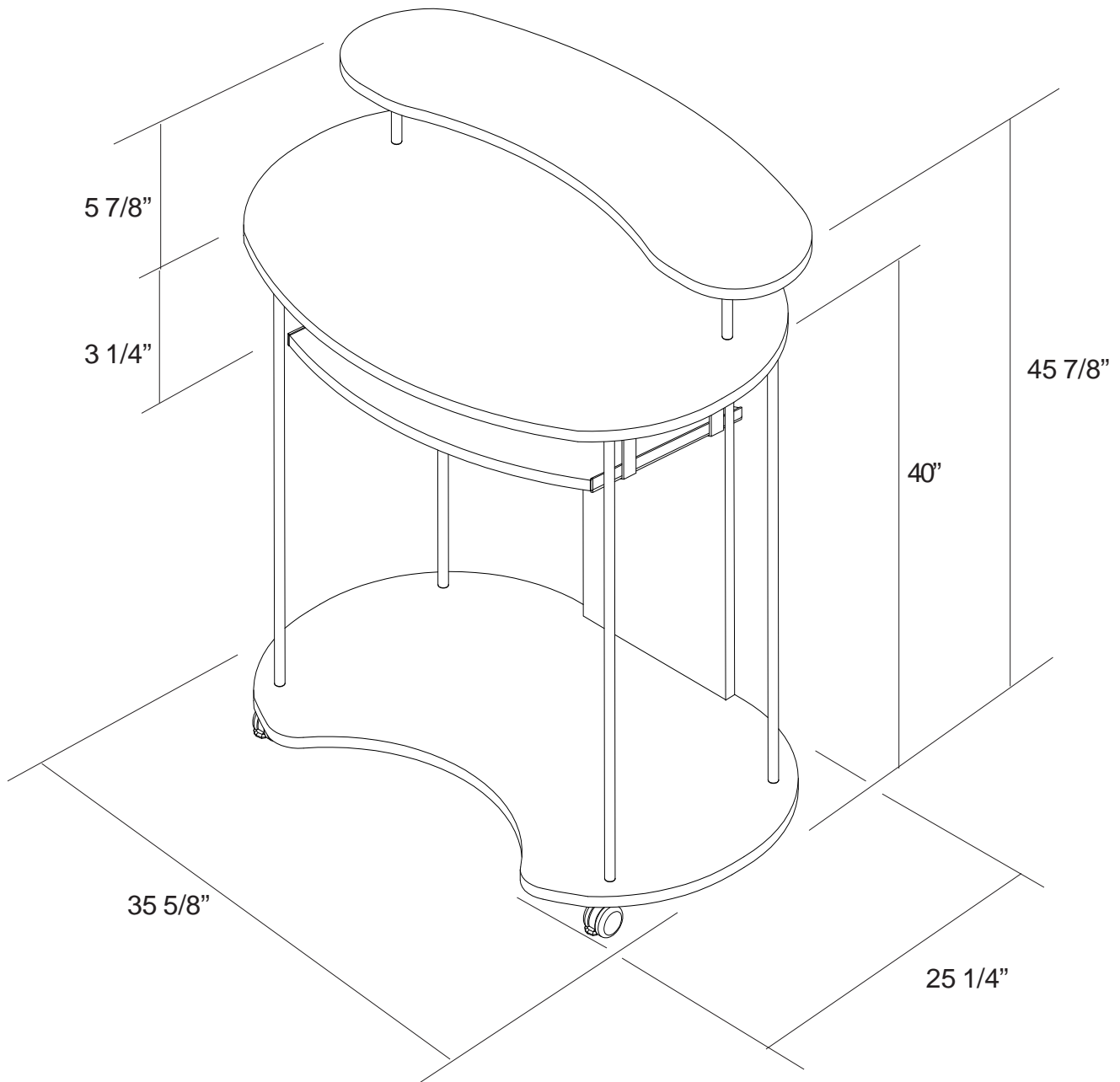

91105_08-25-15